

# Reduced Pressure Zone Device

## Scope of Use / Specification Sheet

The RMC/Flomatic Reduced Pressure Zone Device is designed to give maximum protection to the potable water supply from contamination in high hazard applications such as cooling towers, abattoirs and sewage treatment plants.



SR003C



SR007C

### Product Code

Model	Device Only	Complete	Complete with Lockable Ball Valve
15mm	SR001	SR001C	SR001C-L
20mm	SR002	SR002C	SR002C-L
25mm	SR003	SR003C	SR003C-L
32mm	SR004	SR004C	SR004C-L
40mm	SR005	SR005C	SR005C-L
50mm	SR006	SR006C	SR006C-L
65mm	SR007	SR007C	-
80mm	SR008	SR008C	-
100mm	SR009	SR009C	-
150mm	SR010	SR010C	-
200mm	SR011	SR011C	-

### Description

The RMC / Flomatic Reduced Pressure Zone Device is an economical and durable device that is the easiest on the market to maintain in-line. It consists of two mechanically independent, spring loaded, center stem guided check valves. It also has a hydraulically dependent differential pressure relief valve with the sensing passage set in an integral cast and bronze body, with a single access cover. The assembly has three vertical test cocks and two shut off valves which are quarter-turn, full-port and resilient seated.

The relief valve has a removable stainless steel seat ring. The check valves are held in place by stainless steel clips and the check valve assemblies are non-interchangeable with silicone discs.

### Features and Benefits

- Maximum protection against back siphonage and back pressure
- Internal by-pass passage (no external plumbing)
- Designed for easy and quick in-line maintenance and testing
- Low head loss
- Corrosion resistant
- Maximum working pressure of 1200kPa
- Operating temperature range of 1°C to 82°C up to 50mm BSP Threaded
- Operating temperature range of 1°C to 60°C from 65mm to 200mm Flanged Table E
- Approved to AS 2845-1

### Materials

	15mm - 50mm	65mm - 200mm
Valve Body	Bronze	Ductile Iron
Access Cover	Bronze	Ductile Iron
Polymers	Noryl™, NSF Listed	Noryl™, NSF Listed
Elastomers	Silicone	Silicone, Buna-n (FDA approved)
Springs	Stainless Steel	Stainless Steel
Coating	-	FDA approved fusion epoxy



# Reduced Pressure Zone Device

## Flow Characteristics

### 15-25mm MODEL RPZD

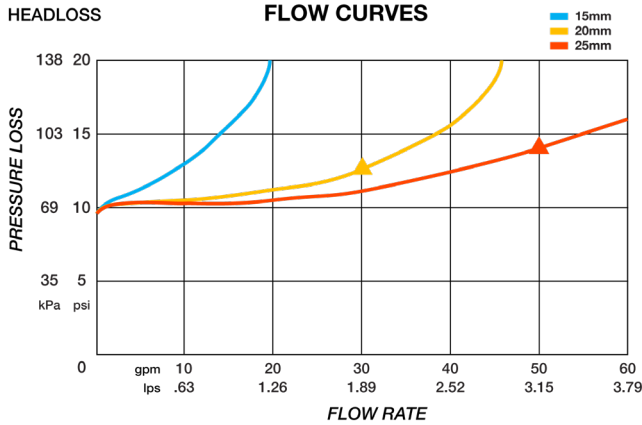

### 32mm MODEL RPZD

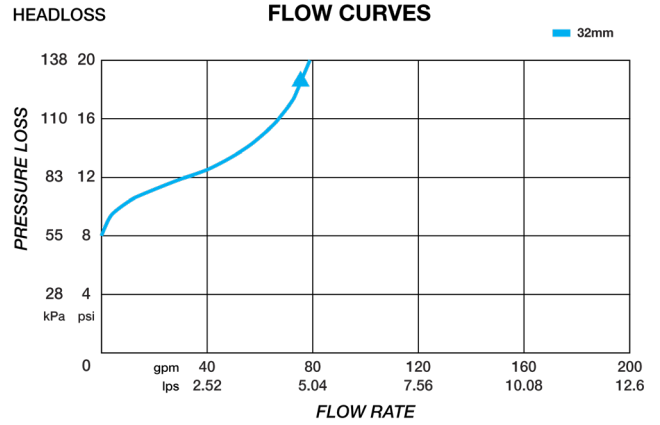

### 40-50mm MODEL RPZD

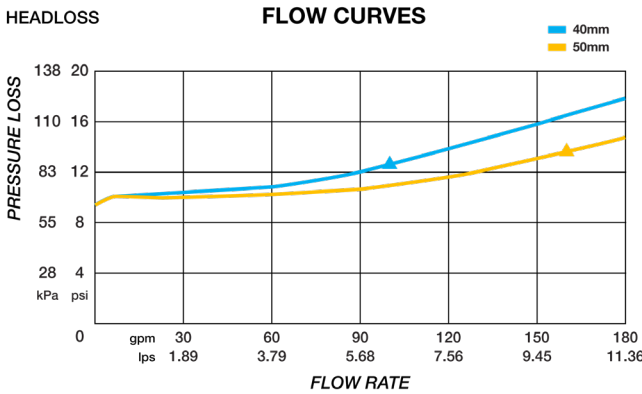

### 65-100mm MODEL RPZD

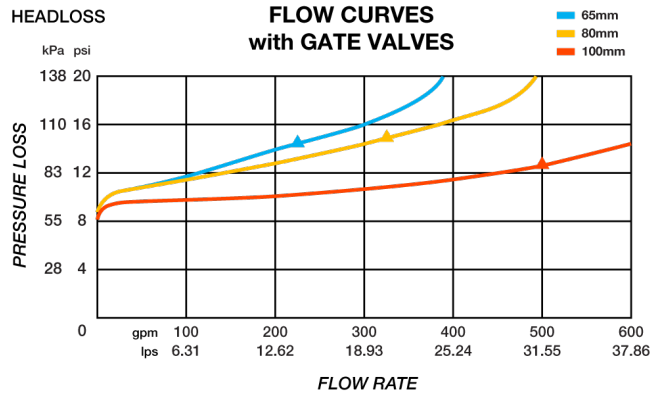

### 150-200mm MODEL RPZD

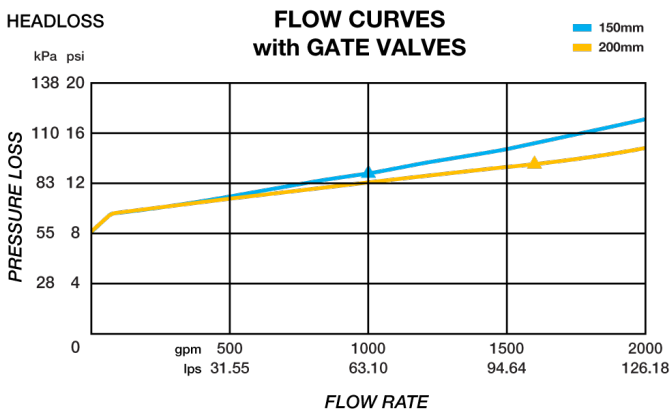

## Performance Specifications

	15mm - 50mm	65mm - 200mm
Maximum working pressure	1200kPa	1200kPa
Maximum working temperature	82°C	60°C
Hydrostatic test pressure	2400kPa	2400kPa
Pipe connection	BSP Threaded	Table E AS2129 Flanged

# Reduced Pressure Zone Device

## Dimensions

Size	Part #	A	B	C	D	Width	Wgt with BV	Wgt less BV
15	SR001C	400	142	140	85	85	2.5	1.5
20	SR002C	430	142	140	85	85	3	1.4
25	SR003C	530	210	155	95	110	5.6	3.3
32	SR004C	620	225	180	95	120	7.8	4.3
40	SR005C	730	315	230	115	150	14.4	10.3
50	SR006C	810	315	220	117	150	15.5	10

Note: All measurements in mm & kg unless otherwise stated.  
Lockable assembly has same dimensions.

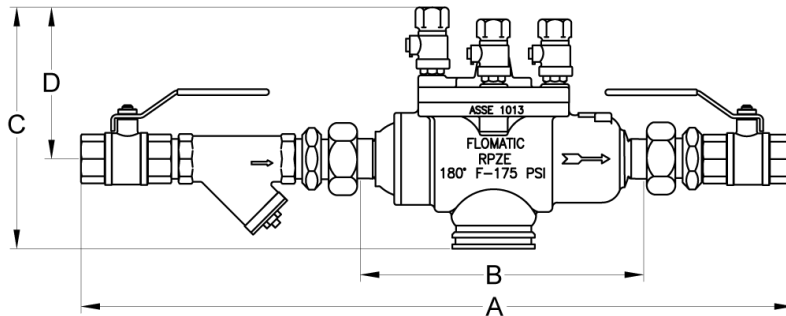

## Dimensions

Size	Part #	A	B	C	D	Width	Wgt with BV	Wgt less BV
65	SR007C	825	450	300	168	204	74.5	27
80	SR008C	850	450	300	170	210	54.6	27.5
100	SR009C	1000	535	460	190	270	142.5	54.5
150	SR010C	1220	630	480	221	330	156.5	84
200	SR011C	1430	765	535	283	390	276	136

Note: All measurements in mm & kg unless otherwise stated.

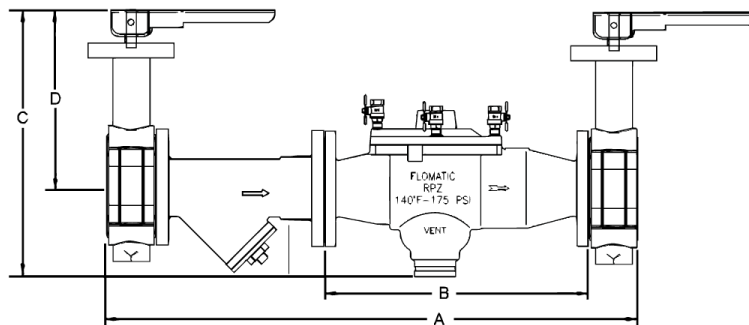

## Reduced Pressure Zone Device

### Standards and Approvals



AS/NZS 2845.1  
WMKA 25926

### Installation

Installation is subject to the requirements of the applicable regulatory authority, the National Construction Code Volume Three – Plumbing Code of Australia, associated reference standards as applicable at the time and AS/NZS 3500.1.

### Warranty

Reliance Worldwide Corporation (Aust.) Pty. Ltd. (RWC) will either replace or repair any defective goods where the defect arose as a result of manufacture within the warranty period. You may contact RWC at the phone number, address or e-mail shown below for further information or to make a claim.

Visit [www.rmc.com.au/warranty](http://www.rmc.com.au/warranty) to view the warranty statement in full and for further important information.